



H110Series Inverter

--Special for carving machine

USER MANUAL

1.2 H110 nameplate

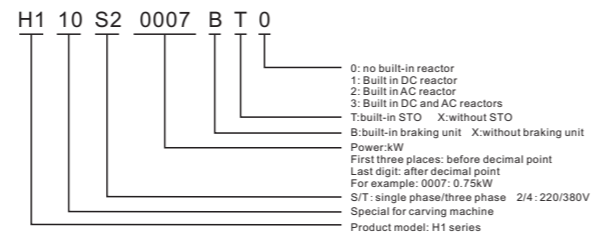

1.3 H110 series specifications and models

Base.No	Models	Input voltage	input current (A)	Power (kW)	output current (A)	Adaptive motor (kW)
F1	H110S20015BX0	1 phase 220V	8.2	1.5	7.0	1.5
	H110S20022BX0	1 phase 220V	14.0	2.2	12.5	2.2
F2	H110T20037BX0	1 phase 220V	23.0	3.7	15.2	3.7
		3 phase 220V	13.5			
F3	H110T20055BX0	1 phase 220V	38.6	5.5	23	5.5
		3 phase 220V	16.5			
F4	H110T20110BX0	3 phase 220V	37	7.5	31	7.5
		3 phase 220V	52			
F1	H110T20150BX0	3 phase 220V	68	15	58	15
		3 phase 220V	58			
F1	H110T40015BX0	3 phase 380V	5.8	1.5	3.7	1.5
		3 phase 380V	6.5			
F2	H110T40030BX0	3 phase 380V	12.6	3.0	7.0	3.0
		3 phase 380V	14			
F3	H110T40055BX0	3 phase 380V	16	5.5	13	5.5
		3 phase 380V	21			
F4	H110T40110BX0	3 phase 380V	28	11	24	11
		3 phase 380V	36			

2.2 Control terminal specification

Terminal identification	Name	Function description
+10V	10Vpower supply	Provide + 10V power supply to the outside, and the maximum output current is 50mA
AI1	Analog input terminal	1. input voltage rang: DC 0V~10V 2. Input current range: 0~20mA 3. Select voltage or current through SW1 jumper
COM	digit, analog ground	Isolate the internal from the communication ground GND
S1~S4	Digital input terminal	1. Optocoupler isolation 2. Input impedance: 2.4k Ω 3. Voltage range at level input: 9V~30V
RA RB	relay output	1. Resistive load: 250VAC 3A/30VDC 3A 2. inductive load: 250VAC 0.2A/24VDC 0.1A(cos φ =0.4)
RJ45	Network port	The keyboard can be led out or connected to the upper computer

2.3 Analog wiring

Because weak analog voltage signals are particularly vulnerable to external interference, shielded cables are generally required, and the wiring distance shall be as short as possible, not more than 20 meters. As shown below:

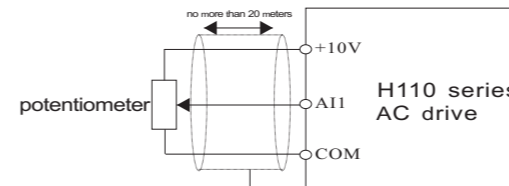

Wiring diagram of analog input terminal

When some analog signals are seriously disturbed, filter capacitors or ferrite magnetic cores need to be added to the analog signal source side. As shown in the figure below:

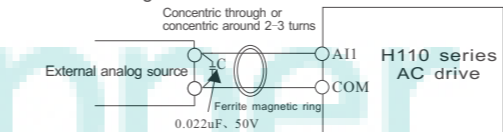

Wiring diagram of analog input terminal plus filter processing

4.2 Indicator light description

Indicator light	Status	Function description
RUN	light on/ flickering	operating /decelerating
REV	light on	reverse operation
REM	light on	remote start stop
ALM	light on	fault indication
M	light on	S1 terminal start indication

4.3 Display item description

Display code	Item description
F	output frequency
C	output current
U	output voltage
d	DC bus voltage
H	Setting frequency
t	Customized display
A	current alarm
E	current fault

NO.5 Carving machine wiring diagram

The application macro has been set for the special AC drive of H110 series carving machine when leaving the factory. The user only needs to set the maximum frequency (P02.18), motor rated power (P06.11), rated voltage (P06.12), rated frequency P06.13), rated current (P06.14) and rated speed (P12.06) according to the motor nameplate. When leaving the factory, the motor parameters are 400Hz and 2400rpm.

Macro setting steps: stop the operation of the AC drive and restore the factory value P01.11 = 2, set the application macro P01.20=84. Finally, set the motor and other parameters.

The speed regulation of carving machine is divided into analog speed regulation and multi-stage speed regulation. The wiring diagram and parameter table of the two control modes are as follows:

5.1 Analog control parameter table

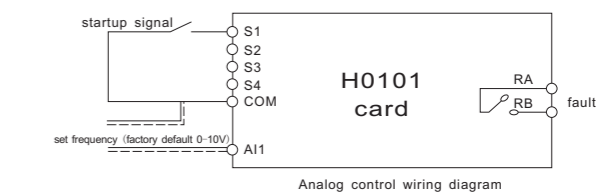

Analog control parameter table

Parameter No.	Function	setting value	description
P01.20	application macro	84	carving machine macro
P02.18	Max. Setting frequency	400.000Hz	Max.Frequency 400.00Hz
P02.50	acceleration time 0	5.000s	acceleration time 5S
P02.70	deceleration time 0	5.000s	deceleration time 5S
P03.00	startup command source	3	S1 terminal startup
P03.30	Y1 terminal source(RA, RB)	4	fault signal output
P03.42	AI1 high level voltage (current)	9.800V(mA)	Maximum voltage/current of input signa
P06.11	motor rated power	set according to motor nameplate	reference to motor nameplate
P06.12	motor rated voltage		
P06.13	motor rated frequency		
P06.14	motor rated current		
P12.06	motor rated speed		

5.2 Multi-stage speed control wiring diagram and parameter table

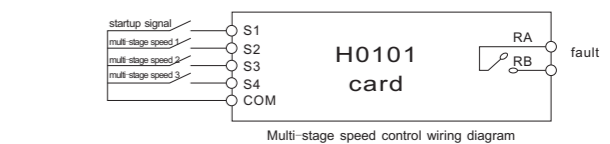

Multi-stage speed control parameter table

Parameter NO.	Function	setting value	description
P01.20	Application macro	84	Carving machine macro
P02.18	Max. Setting frequency	400.000Hz	Max. Frequency 400.00Hz
P02.31	Multi-stage speed 1	25.000%	Relative maximum frequency percentage
P02.32	Multi-stage speed 2	37.500%	
P02.33	Multi-stage speed 3	50.000%	
P02.34	Multi-stage speed 4	62.500%	
P02.35	Multi-stage speed 5	75.000%	
P02.36	Multi-stage speed 6	87.500%	
P02.37	Multi-stage speed 7	100.00%	
P02.50	Acceleration time 0	5.000s	Acceleration time 5s
P02.70	Deceleration time 0	5.000s	Deceleration time 5s
P03.00	Startup command source	3	S1 terminal startup
P03.30	Y1 terminal source(RA, RB)	4	Fault signal output
P06.11	Motor rated power	Set according to motor nameplate	reference to motor nameplate
P06.12	Motor rated voltage		
P06.13	Motor rated frequency		
P06.14	Motor rated current		
P12.06	Motor rated speed		

NO.1 Product introduction

1.1 Technical Features

Items	Description
input	Rated voltage /frequency: 3ph: 380V~440V, 50Hz/60Hz; 1ph: 200V~240V, 50Hz/60Hz
Allowed voltage	3ph: 320V~460V; 1ph: 180V~260V; voltage imbalance rate: <3%; frequency: ±5%
output	Voltage: 0~rated input voltage
Frequency	0Hz~1000Hz
Overload capacity	120% rated current 1 minute
Control mode	V/F, SVC
Modulation Mode	SVPWM
Motor type	asynchronous motor, synchronous motor, single phase motor (consult factory before using)
Start torque	1Hz/150%
Speed range	1:100(SVC)
Frequency accuracy	digital setting: maximum frequency±0.01%; analog setting: maximum frequency±1%;
Frequency resolution	digital setting: 0.1Hz; analog setting: maximum frequency±1%;
Acceleration/ deceleration curve	line/ S-curve
Rapid current limit	limit current rapidly within the current protection value, to ensure the safety of the equipment
None-stop when instantaneous power off	none-stop when instantaneous power off, automatic frequency drop
Operation function	Command source: keypad, terminal, communication
Set value source	digital, analog, multi-speed, communication
Operation panel	LED display: Can display: output frequency, output voltage, output current, Bus voltage, display value 1, display value 2, error, alarm
External keypad	YES
Protection function	over-current protection, over-voltage protection, under-voltage protection, overheating protection, over-load protection, phase lose protection, earth leakage, etc.
Environment	Store environment: indoor, away from direct sunlight, no dust, no corrosive gas, no inflammable gas, no oil mist, no vapour, no drip and no salinity, etc
Altitude	derating use above 1000M, derating 10% per 1000M
Environment temperature	-10℃~+40℃(environment temperature around 40℃~50℃please derating use)
Humidity	5%~95%RH, no condensation
Store temperature	-40℃~+70℃
Vibration	<5.9M/S (0.6g)

NO.2 Wiring diagram for carving machine inverter

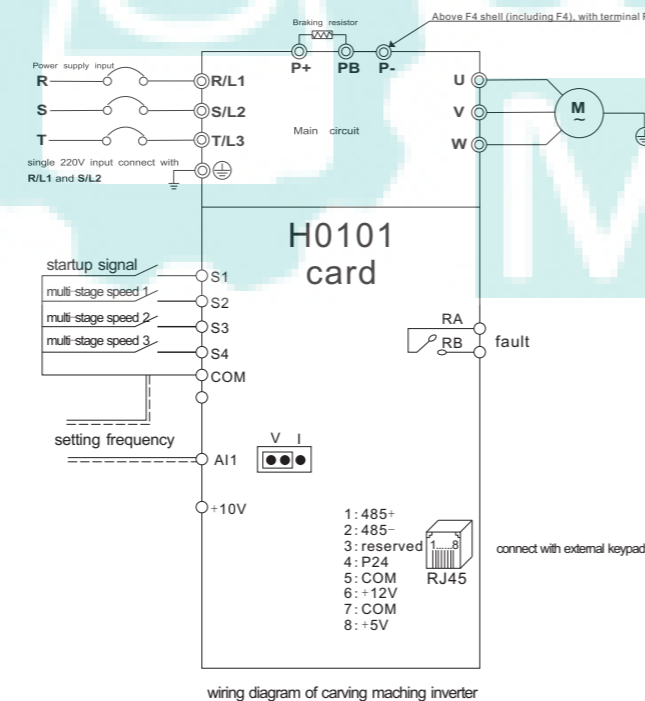

wiring diagram of carving machine inverter

NO.3 Product Dimension

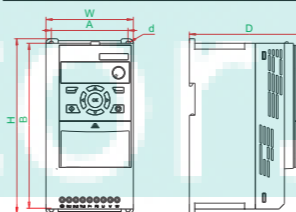

Framework	H110 Series					
	Dimensions (mm)					
	W(Width)	H(Height)	D(Depth)	A	B	d
F1	85	170	124	67.3	158	5
F2	97	194	133	85	184	5
F3	126	237	147	112	223	5
F4	168	298	160	154	283	6

NO.4 Keypad description

4.1 Keypad appearance and keypad explanation

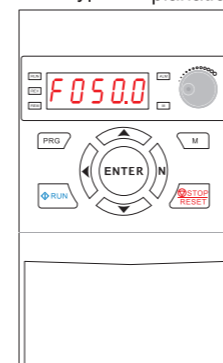

Figure 4-1H110series keypad

Item	Structure	Function description
1	Display	Display
2	Program/exit	Program/exit
3	Status display interface work as status switch key, other interface work as left shift key	
4	Reserved key	
5	RUN	RUN
6	Potentiometer: refer to parameter P01.63	
7	In the mode of program, work as value change key; otherwise, UP/DOWN key, refer to parameter P01.63, P02.03, P02.04	
8		
9	ENTER	Enter
10	STOP/RESET	STOP/RESET
11	Customization key	Customization key

2.1 Main circuit terminal description

Terminal identification	Name	Function description
⊕	Grounding terminal	Safety grounding
R/L1, S/L2, T/L3	Main circuit power input terminal	Connect three phase power supply, single phase power supply connect to R/L1, S/L2
P+, PB	Braking terminal	Connect to external braking resistor
P+, P-	DC bus terminal	Two sets or more inverters use a common DC bus (Above F4 shell (including F4), with terminal P-.)
U, V, W	output terminl	Connect to three phase motor

Multi stage speed comparison table

S4	S3	S2	Effective multi stage speed	Apply macro setting frequency
0	0	1	Multi-stage speed 1	100Hz
0	1	0	Multi-stage speed 2	150Hz
0	1	1	Multi-stage speed 3	200Hz
1	0	0	Multi-stage speed 4	250Hz
1	0	1	Multi-stage speed 5	300Hz
1	1	0	Multi-stage speed 6	350Hz
1	1	1	Multi-stage speed 7	400Hz

0: means S terminal no signal
1: means S terminal has signal

NO.6 Carving machine parameter table

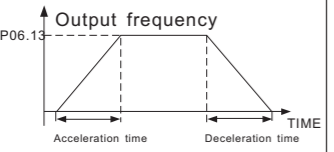
Function code	Function	Description (setting range)	Factory default																																				
P01.11	Parameter operation	0: Normal operation 1: Parameter initialization, initialized parameters except P1.XX 2: Initialize all parameters	0																																				
P01.41	local address	0~247 ⊙Function: set local address of AC drive	1																																				
P01.42	Baud rate	0:2400bps 1:4800bps 2:9600bps 3:19200bps 4:38400bps 5~10:reserved ⊙Function: Communication port configuration	3																																				
P01.43	Parity check	0: No check 1: Even parity check 2: Odd check ⊙function: Communication port configuration	0																																				
P01.44	Data bit	7~8 ⊙function: Communication port configuration	8bits																																				
P01.45	Stop bit	0.0~2.0 ⊙function: Communication port configuration	1.0bit																																				
P02.00	Multi-stage speed source	0~11111111 units: S1 tens: S2 hundreds' digit: S3 thousands' digit: S4 ... * P02.00: multi-stage speed source, select corresponding external terminal, multi-stage speed 0~7 refer to P02.30~P02.37 * Example: select S2, S3 and S4 as effective external terminals to control multi-stage speed, P02.00 is set to 1110, and the specific 8-stage speed correspondence is shown in the table above: <table border="1" style="display: inline-table; margin-left: 20px;"> <tr> <td>S4</td> <td>S3</td> <td>S2</td> <td>Effective multi stage</td> </tr> <tr> <td>0</td> <td>0</td> <td>0</td> <td>Multi-stage speed 0</td> </tr> <tr> <td>0</td> <td>0</td> <td>1</td> <td>Multi-stage speed 1</td> </tr> <tr> <td>0</td> <td>1</td> <td>0</td> <td>Multi-stage speed 2</td> </tr> <tr> <td>0</td> <td>1</td> <td>1</td> <td>Multi-stage speed 3</td> </tr> <tr> <td>1</td> <td>0</td> <td>0</td> <td>Multi-stage speed 4</td> </tr> <tr> <td>1</td> <td>0</td> <td>1</td> <td>Multi-stage speed 5</td> </tr> <tr> <td>1</td> <td>1</td> <td>0</td> <td>Multi-stage speed 6</td> </tr> <tr> <td>1</td> <td>1</td> <td>1</td> <td>Multi-stage speed 7</td> </tr> </table>	S4	S3	S2	Effective multi stage	0	0	0	Multi-stage speed 0	0	0	1	Multi-stage speed 1	0	1	0	Multi-stage speed 2	0	1	1	Multi-stage speed 3	1	0	0	Multi-stage speed 4	1	0	1	Multi-stage speed 5	1	1	0	Multi-stage speed 6	1	1	1	Multi-stage speed 7	1110
S4	S3	S2	Effective multi stage																																				
0	0	0	Multi-stage speed 0																																				
0	0	1	Multi-stage speed 1																																				
0	1	0	Multi-stage speed 2																																				
0	1	1	Multi-stage speed 3																																				
1	0	0	Multi-stage speed 4																																				
1	0	1	Multi-stage speed 5																																				
1	1	0	Multi-stage speed 6																																				
1	1	1	Multi-stage speed 7																																				
P02.10	Setting (frequency) source F1	0: key board 1: multi-stage speed 2: AI1 3: AI2 5: communication key board setting source: P01.63 0: key board digital set 1: key board potentiometer set	1																																				
P02.18	Max. Setting value	0.000~99999.000 * Principle explanation: limit the range of setting value. When each setting source is in%, the maximum setting value (P02.18) represents 100%, means the maximum setting value is taken as the benchmark.	400.000Hz																																				
P02.24	Jog frequency	- 1000.000%~1000.000% Function: set jog frequency, jog command refers to P03.03	10.000%																																				
P02.30	Multi-stage speed 0	Function: multi-stage setting, relative P02.18 Maximum set percentage	0.000%																																				
P02.31	Multi-stage speed 1		25.000%																																				
P02.32	Multi-stage speed 2		37.500%																																				
P02.33	Multi-stage speed 3		50.000%																																				
P02.34	Multi-stage speed 4		62.500%																																				
P02.35	Multi-stage speed 5		75.000%																																				
P02.36	Multi-stage speed 6		87.500%																																				
P02.37	Multi-stage speed 7		100.00%																																				
P02.50	Acceleration time	0.050s~3600.000s * Principle explanation: As shown in the figure, the acceleration time refers to the acceleration from 0Hz to P06.13 time required for rated frequency of motor 	5.000s																																				
P02.70	Deceleration time																																						

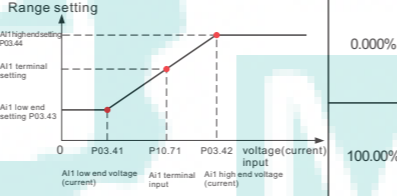
Function code	Function	Description (setting range)	Factory default
P03.00	Startup command source	0: no effect 1: key board 2: communication 3: S1 4: S2 5: S3 6: S4	3
P03.01	Reverse startup command source	3: S1 4: S2 5: S3 6: S4	0
P03.02	Reverse command source	Function: select the command source (when the corresponding command source is the key board, the reverse command, jog command and free parking command all come from the key board custom key M)	0
P03.03	Jog command source		1
P03.04	Stop command source	* Reverse startup command: the setting value is reversed and the start command is issued. * Reverse command: the setting value is reversed. * Jog command: jog function. The priority is higher than the start command and lower than the stop command.	0
P03.05	Free parking command source		0
P03.06	Free parking command source	16 15 14 13 12 11 10 9 8 S14 S13 S12 S11 S10 S9 S8 S7 S6 7 6 5 4 3 2 1 0 S5 S4 S3 S2 S1 Command source Key board No effect	1
P03.30	Y1 terminal source (RA, RB or RA1, RB1)	0: always 0 1: always 1 2: stopped already 3: running 4: fault 5: alarm 6: reversing 7: ready 1350: running at 0 speed 1351: frequency arrived Note: Only when setting carving machine application macro, 1350 and 1351 are valid.	4
P03.32	Y2 terminal source (RA2, RB2)		1351
P03.34	Y3 terminal source (RA3, RB3, RC3)		1350
P03.41	AI1 low end voltage (current)	- 999999.000~999999.000 ⊙function: analog input AI1 setting * AI1 low end voltage (current): set minimum voltage (current) of input signal.	0.200V(mA)
P03.42	AI1 high end voltage (current)	* AI1 high end voltage (current): set Max. Voltage (current) of input signal. * AI1 low end setting: set the corresponding value of low-end voltage. * AI1 high end setting: set the corresponding value of high-end voltage.	9.800V(mA)
P03.43	AI1 low end setting	Range setting 	0.000%
P03.44	AI1 high end setting		100.00%
P05.00	Control mode	0: VF 1: vector control function: Select motor control algorithm	1
P05.20	Stop function	units: 0: free parking; 1: DC braking Tens: 1: Precise parking * Principle explanation: During the stop process, when the output frequency is less than the stop frequency, the stop function starts to work. Precise parking: when parking at any speed, the number of motor turns is the same, so as to realize the one-to-one repeatability of parking position. To achieve the best results, the deceleration time shall be extended as far as possible without triggering the over voltage and over current stall prevention function.	1
P05.21	Stop frequency	0.000Hz~1000.000Hz The explanation refers to P05.20	10.000Hz
P05.22	DC braking current	0.000%~300.000% Set the current of DC braking	100.000%
P05.23	DC braking time	0.000s~1000.000s When it is set to 1000.000, keep braking until the free stop or startup signal is received.	1.000s
P06.05	Carry frequency	2kHz~16kHz ⊙Function: Set carry frequency	*kHz
P06.11	Motor rated power	0.000kW~100000.000kW ⊙Function: Set motor rated parameter	*kW
P06.12	Motor rated voltage	0V~1000V ⊙Function: Set motor rated parameter	*V
P06.13	Motor rated frequency	1Hz~3000Hz ⊙Function: Set motor rated parameter	400Hz
P06.14	Motor rated current	0.00A~1000.00A ⊙Function: Set motor rated parameter	*A
P10.61	Current fault	-	0
P10.62	Previous fault	-	0
P10.63	The first two faults	-	0

Function code	Function	Description (setting range)	Factory default
P11.10	Output frequency of current fault	-	0.0Hz
P11.11	Output current of current fault	-	0.00A
P11.12	Bus voltage of current fault	-	0.0V
P11.13	AC drive temperature of current fault	-	0°C
P11.14	S terminal status of current fault	-	0
P11.15	Y terminal status of current fault	-	0
P11.16	Cumulative power on time of current fault	-	0.000h
P12.06	Motor rated speed	10rpm~65535rpm ⊙Function: Set motor parameter	24000rpm

NO.7 Fault code

Fault Code	Protection function	Description
E0001	system abnormality	AC drive hardware failure or software failure
E0004	ground fault	Abnormal resistance to ground, cause electric leakage
E0005	short circuit to ground	short circuit to ground
E0006	output short circuit	inverter cut off output when inverter output current is 250% larger than inverter rated current.
E0007	output over current	inverter cut off output when inverter output current is 200% larger than inverter rated current.
E0008	DC bus over voltage	inverter cut off output if main circuit DC voltage is higher than 400V(220V motor type) or 800V(380V motor type) when motor decelerates.
E0009	DC bus low voltage	input voltage decrease, inverter cut off output if main circuit DC voltage too low.
E0010	inverter over heat	inverter cut off output if cooling fan is over heat.
E0011	self-learning failure	self-learning parameter wrong or motor abnormal.
E0013	rectifier over heat	rectifier module over heat.
E0014	U phase loss	output U phase loss.
E0015	V phase loss	output V phase loss.
E0016	W phase loss	output W phase loss.
E0019	no motor connect	motor lost connection during operation.
E0020	input phase loss	power input phase loss.
E0021	inverter over load	inverter cut off output when inverter output current ex (120%) 60S
E0022	over torque	motor over torque
E0024	motor over heat	motor temperature is over heat.
E0025	motor over load	inverter cut off output when inverter output current ex (120%) 60S
E0026	current limit	output current exceed setting limit threshold.
E0027	Input power down	The input voltage is lower than the power down standard value (P05.86)
E0033	ST0	Safe torque output stop function operation
E0034	ST1	Alarm of ST1 internal circuit diagnosis
E0035	ST2	Alarm of ST2 internal circuit diagnosis
E0036	ST3	Alarm of internal circuit diagnosis
E0063	user fault	user defined fault(P03.08)

Note: The alarm code is compared to the above table, for example: the keyboard displays "A0025" which means the motor overload alarm.