

END COVER COLOR : BLACK

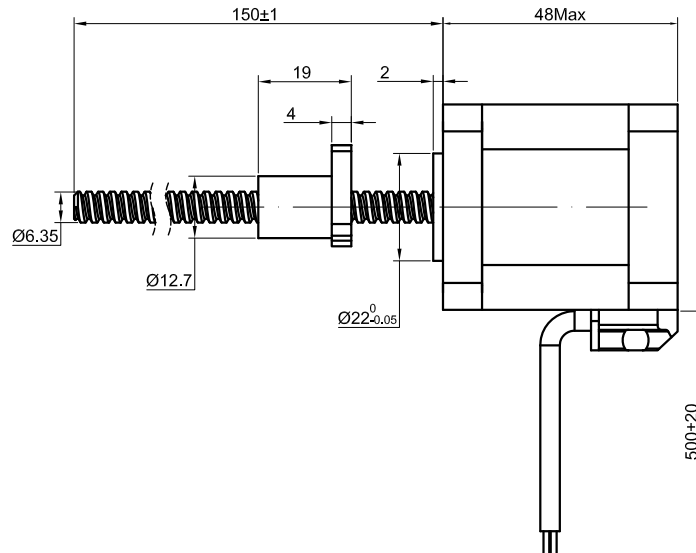
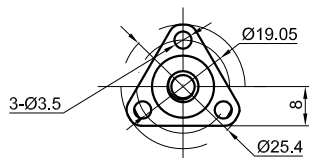
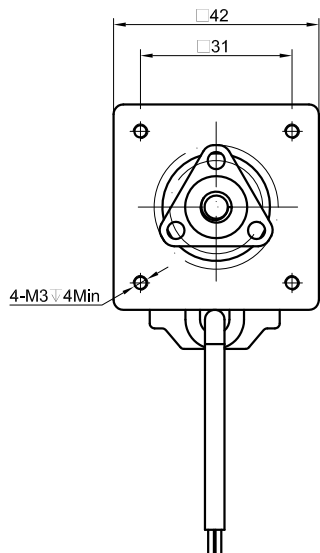

SPECIFICATION	CONNECTION	BIPOLAR
AMPS/PHASE		2.50
RESISTANCE/PHASE(Ohms)@25°C		0.8±10%
INDUCTANCE/PHASE(mH)@1KHz		1.8±20%
HOLDING TORQUE(Nm)[lb-in]		0.5[4.43]
LEAD(mm)		25.4
LINEAR TRAVEL/STEP(mm)		0.127
STEP ANGLE(°)		1.80
STEP ACCURACY(NON-ACCUM)		±5.00%
WEIGHT(Kg)[lb]		—
TEMPERATURE RISE:MAX.80°C (MOTOR STANDSTILL;FOR 2PHASE ENERGIZED)		
AMBIENT TEMPERATURE -10°C~50°C[14°F~122°F]		
INSULATION RESISTANCE 100 Mohm (UNDER NORMAL TEMPERATURE AND HUMIDITY)		
INSULATION CLASS B 130°C[266°F]		
DIELECTRIC STRENGTH 500VAC FOR 1MIN.(BETWEEN THE MOTOR COILS AND THE MOTOR CASE)		
AMBIENT HUMIDITY MAX.85%(NO CONDENSATION)		

TYPE OF CONNECTION (EXTERN)		MOTOR	
PIN NO	BIPOLAR	LEADS	WINDING
1	A —	RED	
2	A\ —	RED/WHT	
3	B —	GRN	
4	B\ —	GRN/WHT	

FULL STEP 2 PHASE-Ex. ,
WHEN FACING MOUNTING END (X)

STEP	A	B	A\	B\		CCW
1	+	+	-	-	↓	↑
2	-	+	+	-		
3	-	-	+	+	↑	↓
4	+	-	-	+		

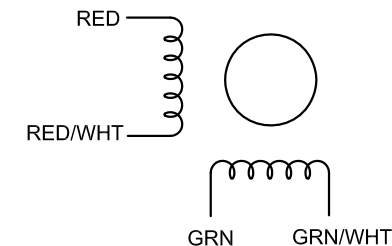

	APVD		1.30.2023
	CHKD		
1:1	DRN		
SCALE	SIGNATURE		DATE

STEPPER MOTOR

17E19S2504YF5-150RS